



SINCE 1932

Dickinson Marine
#407-204 Cayer St Coquitlam
BC Canada V3K 5B1

www.dickinsonmarine.com
info@dickinsonmarine.com

T: 800 659 9768

F: 604 525 6417

Propane 2Burner Drop-in Cooker

INSTALLATION – USE AND CARE MANUAL

This manual MUST be read carefully



DICKINSON RESERVES THE RIGHT TO CHANGE PRODUCTS OR DOCUMENTS AT ANY TIME

Please Read Before using your cooktop

QUALITY INSPECTED BY- Doug & Don

DATE- July 1 / 2008



WARNING:

If the information in this manual is not followed exactly, a fire or explosion may result causing property damage, personal injury, or loss of life.







— Do not store or use gasoline or other flammable vapors and liquids in the vicinity of this or any other appliance.

— **WHAT TO DO IF YOU SMELL GAS**

- Do not try to light any appliance.
- Do not touch any electrical switch.
- Shut off main supply tank, and call the fire department if the boat has filled with gas.

IMPORTANT

Safety is everyone's responsibility. Your Dickinson product is designed and constructed to give you many years of safe use. The operation will be further enhanced if proper care and judgment are exercised in the use and maintenance of the appliance.

	THIS APPLIANCE IS DESIGNED FOR LPG ONLY
	IMPORTANT: <u>Read this owner's manual carefully and completely before trying to assemble, operate, or service this appliance. Improper use of this gas appliance can cause serious injury or death from burns, fire, explosion, carbon monoxide poisoning and oxygen depletion. For assistance or additional information consult a qualified installer, service agency, or your gas supplier.</u>
	TEST ALL PROPANE LINES AND CONNECTIONS FOR LEAKS WITH A SOAPY WATER SOLUTION. DO NOT FLAME TEST FOR LEAKS.
	CLOSE THE LPG CYLINDER VALVE WHEN APPLIANCE IS NOT IN USE
	<u>CLOSE THE LPG CYLINDER VALVE IN THE EVENT OF AN EMERGENCY</u>
	WARNING: <ul style="list-style-type: none">• DO NOT install this appliance in spaces containing internal combustion engines, their fuel tanks, or joints and fittings of their fuel systems.

	<ul style="list-style-type: none"> • USE ONLY approved materials, hose, regulators and fittings to install. 10ft Hose – ULC Type III CGA St 8.1 – Dickinson Prt# 19-100-10 20ft Hose – ULC Type III CGA St 8.1 – Dickinson Prt# 19-100-20 Propane Low Pressure Regulator UL/C.G.A – Dickinson Prt# 19-151 • DO NOT store or use gasoline or other flammable vapors and liquids in the vicinity of this or any other appliance. • INSTALLATION must conform with local codes or in the absence of codes, with current National Fuel Gas Code, ANSI Z223.1 or current CAN/CGA B149, Installation Codes. • MANUFACTURED OR MOBILE HOME OEM installation must conform to Manufactured Home Construction and Safety Standard, Title 24 CFR, Part 3280, or, when not applicable, the Standard for Fire Safety Criteria for Manufactured Home Installation Sites and Communities, ANSI/NFPA 501A,(USA) or Mobile Homes Standard, CAN/CSA-Z240 MH Series, in Canada • MAIN GAS VALVE must be disconnected from gas supply system during any pressure test of the system at pressures greater than ½ psi (3.5 kPa)
	<p>IMPORTANT: <u>Save this manual for future reference.</u></p>

WHAT TO DO

1. Begin by ensuring proper installation and verify that the appliance has been connected to the type of gas on which it is intended to operate.
Be familiar with the location of the gas shut-off.
If you smell gas, do not use the appliance. Immediately turn off the gas supply at the shut-off valve.
2. Use this appliance only for its intended purpose as described in the manual.
3. Never let clothing or other flammable materials come in contact with the burners while in operation.
4. When cooking, set the burner controls so that the flame heats only the bottom of the pot and does not lick at the sides of the pot.
5. Always turn pot handles to the side or back of the appliance. Do not turn handles towards the front where they are easily hit. Handles should not extend over adjacent burners.
6. Always check the position of the control knobs to make sure the appliance is off when you are finished cooking.
7. Always light each burner prior to placing a pot on the burner grate. Also, turn the control knob to the “off” position before removing a pot from the burner grate
8. Wait until the appliance has cooled before cleaning.
9. Always keep the appliance surface clean and dry.

WHAT NOT TO DO

1. DANGER-Never use the appliance to warm or heat the room.
2. When using the appliance do not touch the grate, burner caps, burner bases or any parts in proximity to the flame.
3. Do not leave children alone or unattended in the area where the appliance is in use.
4. Do not use water on grease fires.

5. Never leave the appliance unattended when in use.
6. Do not use oversized pots or pans. See section on 'burners'.
7. Do not use abrasive or caustic cleaners or detergents on this appliance.
8. Keep appliance area clear and free from combustible material.

PACKING LIST

INSTRUCTION MANUAL
TWO BURNER DROP IN COOKTOP
SNAP IN GRILL SECTION
POT HOLDER RAIL
POT HOLDERS (2)
¼ x 20 S/S SCREW (4)
ANGLE BRACKETS (4)
CUTTING BOARD

PRODUCT FEATURES

Your two-burner gas cook top contains many unique features. Please read this section carefully as it identifies the most important.

COOKING GRATE

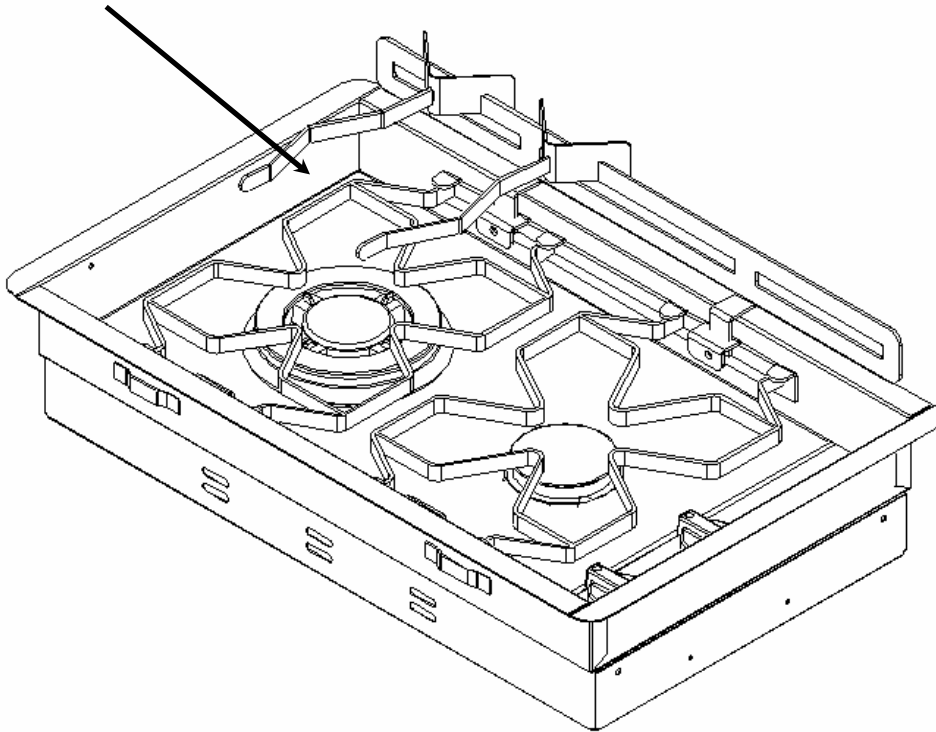

The cooking grate is designed to snap into place to ensure that it is level and to limit vibration.

IMPORTANT NOTE – The stainless grate and burner tops are exposed to extreme temperatures in a matter of seconds. In addition pots are slid over them and spills introduce foods with high acidity to all of the surfaces and components. These severe operating conditions will cause an inevitable change in the appearance of the surfaces and components. Meticulous care and cleaning will slow but not eliminate these changes.

POT HOLDERS AND RAIL

There is a set of potholders and a potholder rail standard with your appliance. The rail is attached, as shown in the diagram, by inserting the legs into the grate and tightening the brass thumbscrews. The grate can be removed and turned to position the sea rail at the back or front as required. The potholders are then slipped over this rail and moved to fit the size of pot or pan by squeezing the end legs so they can slide back and forth. Should the potholders become loose simply spread the legs a little and they will again become secure. It is recommended that the potholders be used when any boat motion is anticipated. The rail can be detached and stored under the fitted cutting board.

CUTTING BOARD ACCESSORY

The board is used to provide a flat finished surface at counter top level. It also provides a useful cutting-board feature that can be used in place or elsewhere.

CUTTING BOARD LEVELING FEATURE

At the four outside corners of the cooking grate there are small tapped holes. If your counter top is not absolutely flat the cutting board will not lie flat on the grate. By installing 4 – 8-32 screws into the tapped holes, with the screw head up, the cutting board can be leveled. It is advisable to tighten the levelers with a nut on the underside to secure them in place

BURNERS

The top surfaces of the burner caps are porcelain enameled to prevent oxidation (rusting) and to provide an attractive finish.

Triple Burner

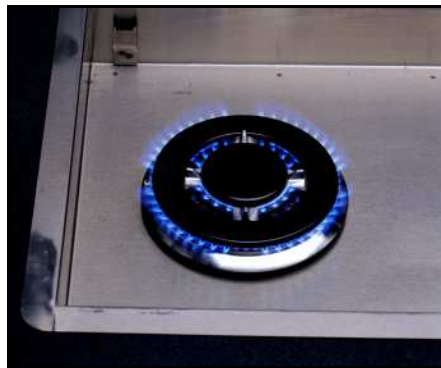

These burners are CGA/AGA approved

FLAME DISPERSION

The burner ring spreads the flame evenly around the burner perimeter. This burner assembly must be seated properly into the base to produce the desired flame configuration.

FLAME CLEARANCE AND POT SIZES

Space is always at a premium on a boat and the Dickinson *Two Burner Drop In Cooktop* gives you the most versatility and the most powerful burners available in a marine cooktop format. For your safety and for the good maintenance of the appliance, use the appropriate size pots for the right and left burners. On the left, a pot with a 10 inch base is appropriate. On the right hand side it is best not to use pots or pans with bottoms greater than 6 inches in diameter.

BURNER SAFETY FLAME-OUT

Each burner is equipped with a thermo-couple safety sensor. Should the flame accidentally be extinguished the sensor will automatically turn-off the gas supply to the burner. In addition, should the burner not ignite on start-up the gas will not continue to flow to the burner when the control knob is released.

BURNER IGNITER

The burner igniter is located on each burner and is activated by a battery generator. (Battery Included – 9v) This igniter box is located under the control panel of the appliance below the burner control knobs. To replace the battery pull off the knobs and remove the cover plate by removing the two securing screws. Unscrew the large black plastic knob on the battery holder. Replace battery.

BURNER FENCE

Due to the constricted space available on a boat and in marine appliances, a heat shield fence has been installed between the right hand burner and the control knob. This allows the knobs to stay cool to the touch while the appliance is in use. Please be careful not to touch the fence or handle it until the appliance has cooled off.

GAS CONTROL VALVES

This appliance is equipped with CGA/AGA approved quality gas valves that offer both electronic ignition and thermocouple flameout safety features. These valves have been calibrated for use with the burners to produce the required BTU heat output and flame quality at all settings

GAS SUPPLY AND HOOK-UP

THE COOK TOP OPERATES ONLY ON LOW PRESSURE LPG GAS (11" w/c)

It is recommended that a dedicated gas line and low-pressure(11" wc) regulator (Dickinson Prt No 19-151) be installed.

Connect the gas line to the 3/8" flare connector of the cook top with copper or an approved hose. During this procedure some particles may get into the fuel line. These could block or restrict the burner orifices.

BLOW OUT FUEL LINE PRIOR TO ATTACHING TO THE PROPANE SUPPLY AND THE APPLIANCE OR TAPE OVER THE FITTING WHEN INSTALLING THE FUEL LINE SO NO DEBRI WILL ENTER.

PORTABLE PROPANE BOTTLE

If you do not have a low pressure propane system on board and intend to use a portable propane bottle it is necessary to install a pressure regulator for gas supplied from the propane bottle. For this type of installation we suggest using a Dickinson Low Pressure Kit (Part No. 19-150) This Kit includes a pressure regulator (11 ins W/C), a hose or 1lb bottle connector fitting and a mounting kit. The Kit must be mounted outside and away from a hatch or entry. A Dickinson AGA/CGA propane hose can be used to connect this Kit to the heater. These are available in 10 ft (3m) (Part No. 19-100-10) or 20 ft (6m)(Part No. 19-100-20)

AFTER GAS HOOK-UP AND BEFORE LIGHTING THE APPLIANCE TEST ALL GAS CONNECTIONS FOR LEAKS WITH A SOAP SOLUTION

TYPICAL LPG ON-BOARD SYSTEM

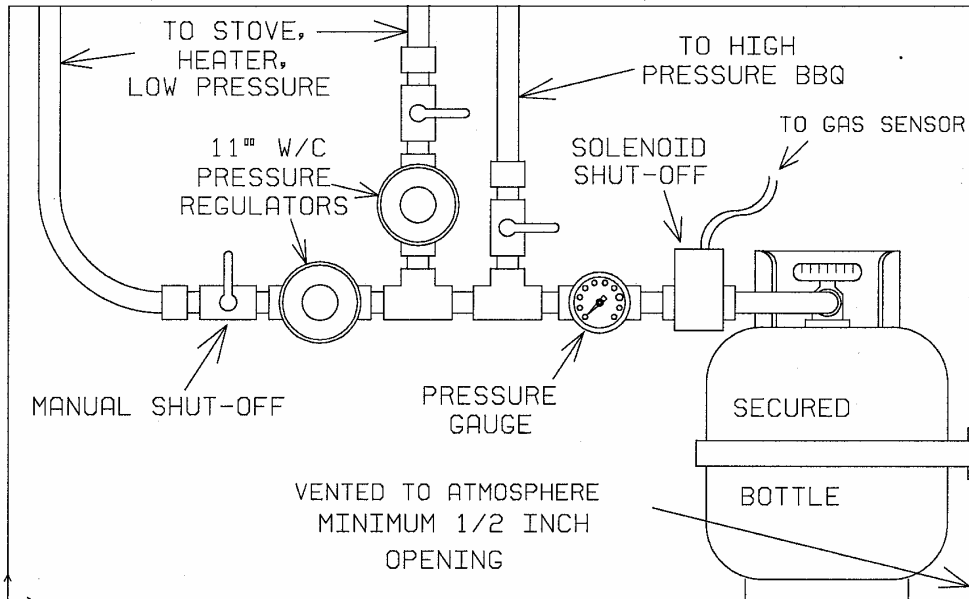



WARNING:

- DO NOT install this appliance in spaces containing internal combustion engines, their fuel tanks, or joints and fittings of their fuel systems.
- USE ONLY approved materials, hose, regulators and fittings to install.
10ft Hose – ULC Type III CGA St 8.1 – Dickinson Prt# 19-100-10
20ft Hose – ULC Type III CGA St 8.1 – Dickinson Prt# 19-100-20
Propane Low Pressure Regulator UL/C.G.A – Dickinson Prt# 19-151
- DO NOT store or use gasoline or other flammable vapours and liquids in the vicinity of this or any other appliance.
- INSTALLATION must conform with local codes or in the absence of codes, with current National Fuel Gas Code, ANSI Z223.1 or current CAN/CGA B149, Installation Codes.
- MANUFACTURED OR MOBILE HOME OEM installation must conform to Manufactured Home Construction and Safety Standard, Title 24 CFR, Part 3280, or, when not applicable, the Standard for Fire Safety Criteria for Manufactured Home Installation Sites and Communities, ANSI/NFPA 501A,(USA) or Mobile Homes Standard, CAN/CSA-Z240 MH Series, in Canada
- MAIN GAS VALVE must be disconnected from gas supply system during any pressure test of the system at pressures greater than ½ psi (3.5 kPa)

INSTALLATION

COUNTERTOP PREPARATION

Prior to preparing the countertop check that the depth of the cook top will fit in the desired location and that there is room for the gas inlet fitting and the gas lines. The 3/8" flare inlet fitting protrudes 3/4" below the depth of the appliance.

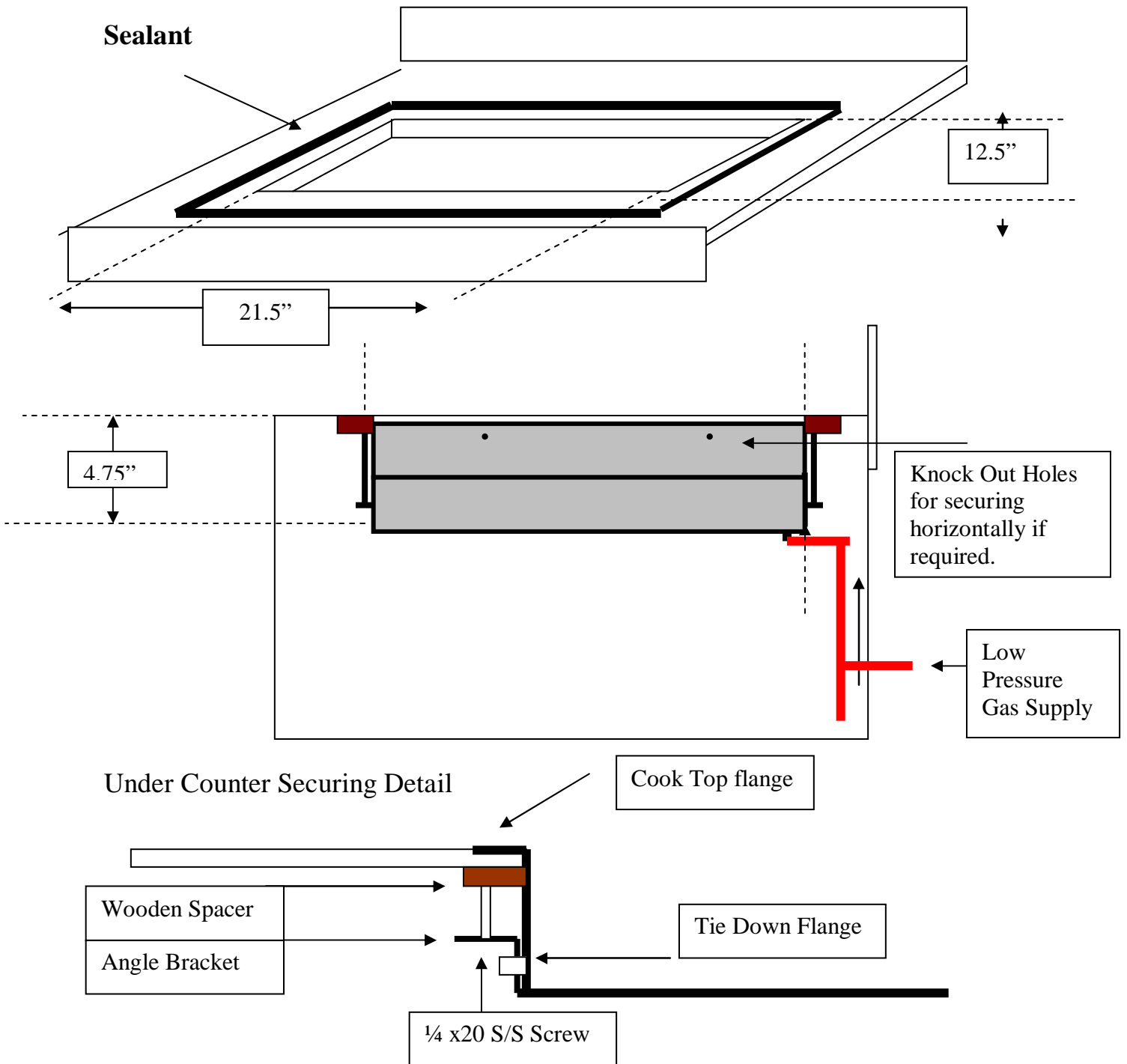

INSTALLATION

Installing when you have access under the countertop.

- Ensure the cut out dimensions. A small bead of sealant is recommended for a good seal.
- Install the four metal angle brackets into the tie down flanges that are on the side of the housing. The flanges should be inserted so the bracket slides **DOWN** into the flange slot and the threaded hole is facing the countertop and not the housing.
- Thread the four stainless steel machine screws into the brackets. The ends of the screws will contact the countertop. Depending on the thickness of your counter material you may need a wooden spacer at the points where each of the four mounting screws go. Stop turning when all four corners are tight.
- These brackets will prevent the appliance from becoming unseated due to vibrations or the motion of the boat.

Installing when you do not have access under the countertop.

- It may occur that you do not have access to the underside of the countertop where the Cooktop is to be installed. If this is the case, locate the four ‘knock out slugs’ on the inside of the appliance housing. They are small and on the side walls about 2.25” above the bottom of the inside of the cooker.
- Punch out or work out the slugs so you are left with four clear holes.
- Follow the instructions indicated above on cut out dimensions and sealant.
- Place the appliance into the cut out. Use four stainless sheet metal screws in the ‘knock out holes’ to secure the appliance to the countertop material.
- If the countertop material is especially thin, drill out guide holes before driving in the screws.
- These screws will prevent the appliance from becoming unseated due to vibrations or the motion of the boat

OPERATION

LIGHTING THE BURNERS

WARNING : BEFORE LIGHTING BURNERS REMOVE ALL FLAMMABLE MATERIALS E.G. CURTAINS, TOWELS ETC. FROM THE IMMEDIATE VICINITY.

Ensure burners are properly seated in their base.

Each knob controls a different valve. To light the burner press down on the knob to activate the electronic ignition. Rotate the knob counter clockwise until the red dot is level with the thickest part of the indicator line. The burner will then light with the flame at the high setting. Continue to rotate counter clockwise to select lower flame settings.

The igniters on both burners will spark continuously until the gas ignites on the selected burner. Ignition should occur within four seconds of turning to this position. The igniters will stop sparking as soon as the knob is released.

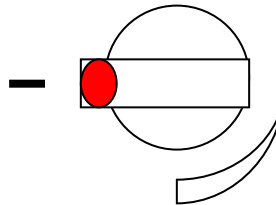

- 1. PRESS KNOB DOWN**
- 2. TURN KNOB COUNTERCLOCKWISE TO HIGH POSITION UNTIL BURNER IGNITES, AFTER IGNITION CONTINUE ROTATING COUNTERCLOCKWISE TO SET THE DESIRED FLAME HEIGHT.**

IMPORTANT

1. If the gas does not ignite within four seconds, then turn off the valve. Allow at least a minute for any gas to dissipate, and then repeat the lighting process.
2. Do not touch any burner cap, burner base or igniter while igniters are sparking as an electrical shock could result.
3. The flame should be steady and blue in color. Foreign material in the gas line, especially in new installations, may cause an orange flame during initial operation. This will disappear with further use.
4. The flame should burn evenly around the perimeter of the burner. If the flame is uneven ensure that the burner covers are properly positioned.
5. If a burner does not ignite, consult the Trouble Shooting Guide.

NOTE: Wait until the cook top is cool before installing the cutting board or damage will occur to the board.

CARE AND CLEANING

WARNINGS:

1. Before cleaning the cook-top ensure that the burners are turned off and that all components are cool enough to safely touch.
2. After cleaning re-assemble all components before attempting to operate the cook-top.

Proper cleaning is necessary to maintain appliance performance and appearance. Wipe up spills that occur while cooking, but wait for cooker to cool. Spills that remain on hot burner components will be very difficult to clean, especially if allowed to burn on. Spills of certain foods, such as tomatoes, citrus juices, vinegar, alcohol and milk are harmful if allowed to stand for any length of time.

Use the mildest cleaner available to perform the cleaning operation. Use only a sponge and soft cloth, fibrous or nylon pad for cleaning. Do not use abrasive cleaners such as steel wool. Always dry components completely before using the cook top.

CLEANING ORIFICE

The orifices of both burners are easily accessed. The large burner cap and body is simply lifted off the burner base support. This reveals the small hole which is the gas inlet orifice. The small burner cap is unscrewed counterclockwise. Remove the two small screws on top of the burner base and then lift off the assembly. It is advisable to unscrew and remove the orifice for cleaning. Cleaning the orifice in place may result in a repeat blockage soon after re-using the cook-top.

LOWER COMPARTMENT

The lower compartment can be accessed when the appliance is removed from the countertop cut-out. This compartment should be accessed for igniter box replacement, thermocouple replacement, sparker wire shorting or replacing, or for cleaning after a large spill.

Remove the two control knobs by pulling them off.

- Remove the left hand burner top by lifting it out.
- Remove the right hand burner by unscrewing the burner cap and removing the two screws that hold the burner down .
- Remove the four stainless sheet metal screws on the outside panels of the Cook Top.
- The top of the appliance will now lift off.

TROUBLE – SHOOTING GUIDE

No gas to burners	-	Supply tank empty Shut-off valve closed Burner orifice blocked
Poor quality flame	-	Burner top not installed correctly Dirt in the fuel line Partially blocked orifice
Low flame	-	Supply tank low pressure Partially blocked orifice
Igniter does not spark.	-	Igniter generator battery requires replacing (9v) Igniter box replacement Electrode sparker wire shorting or needs replacing
Cutting Board uneven	-	See Cutting Board Leveling Feature above
Pot Holders are loose	-	Spread legs by hand

LIMITED WARRANTY

WARRANTY PROVISIONS : dickinson warrants this product to be free of defects in workmanship and materials for a period of one year. This warranty is limited to claims submitted in writing within a one-year period following the date of purchase. If any part of your new product fails because of a manufacturing defect within the warranty period dickinson offers to replace said parts free of charge, provided, however, that such parts have not been improperly repaired, altered or tampered with or subjected to misuse, abuse or exposed to corrosive conditions. This warranty, however, is limited by certain exclusions, time limits and exceptions as listed below. Read these limitations and exclusions carefully.

TIME LIMIT : This warranty is given too and covers only the original purchaser. Coverage terminates one year from the date of purchase for parts replacement.

EXCLUSIONS : This warranty does not cover or include : (a) Any normal deterioration of the product and appearance of items, due to wear and/or exposure; (b) any guarantees, promises, representations, warranties or service agreements given or made by an authorized distributor or other person selling this product, other than those specifically stated herein; (c) any damage or defect due to accident, improper repair, alteration, unreasonable use including failure to provide reasonable and necessary maintenance, misuse or abuse of the equipment, or exposure to corrosive conditions. This warranty is conditioned upon normal use, reasonable and necessary maintenance and service of your product, and written notice being given promptly upon Buyer's discovery of a warranty claim, pursuant to paragraph 6 below. Reasonable and necessary maintenance is maintenance which you are expected to do yourself or have done for you. It is maintenance, which is necessary to keep your product performing its intended function and operating at a reasonable level of performance.

DAMAGE LIMITATION WARNING : IN NO EVENT SHALL dickinson BE LIABLE FOR ANY INCIDENTAL OR CONSEQUENTIAL DAMAGES, INCLUDING (BUT NOT LIMITED TO) LOSS OF USE OF THE PRODUCT, LOSS OF TIME, INCONVENIENCE, EXPENSES FOR TRAVEL, LODGING TRANSPORTATION CHARGES, LOSS BY DAMAGE TO PERSONAL PROPERTY OR LOSS OF INCOME, PROFITS OR REVENUE.

ORAL OR IMPLIED WARRANTY LIMITATIONS : The foregoing warranty is exclusive and in lieu of all other warranties, written or oral, expressed or implied, including but not limited to any warranty or merchantability or fitness for a particular purpose.

TRANSFER LIMITATIONS : This warranty is not assignable or transferable. It covers only the original purchaser

CLAIM PROCEDURE : In the event of a defect, problem or that a breach of this warranty is discovered, in order to protect any warranty rights you must promptly notify dickinson. Give name, address, and model name, location of unit, description of problem and where you can be reached during business hours.

RESERVED RIGHT TO CHANGE : dickinson reserves the right to make changes or improvements to products it produces in the future without imposing on itself any obligations to install the same improvements in the products it has previously manufactured.

SECOND OR SUBSEQUENT OWNER : dickinson does not give any warranty to secondary or subsequent purchasers, and it disclaims all implied warranties to such owners.

INSPECTION : To assist you in avoiding problems with your product and to validate this warranty you are required to do the following : (a) read the warranty; (b) inspect the product. Do not accept delivery until you have examined the product with your supplier; (c) ask questions about anything you do not understand concerning the product.

OWNER REGISTRATION : Fill out the **WARRANTY CARD** within 30 days from the date of delivery.
WARRANTY : RETURN OF THE CARD IS CONDITION PRECEDENT TO WARRANTY COVERAGE AND PERFORMANCE. IF YOU DO NOT FILL OUT AND MAIL THE CARD AS DIRECTED, YOU WILL NOT HAVE A WARRANTY.

LEGAL RIGHTS : This warranty gives you specific legal rights and you may also have other rights, which may vary within different government jurisdictions.

Return to:



SINCE 1932

#407 – 204 Cayer Street, Coquitlam, B.C. Canada V3K 5B1

WARRANTY FORM

I have read and understand the Limited Warranty and the Instruction Manual
and agree to the terms and conditions

(please print)

Date.....

Purchaser's Name.....

Address.....

.....

.....

Model Name..... **2 Burner Drop In**.....

Serial Number.....

Date Of Purchase.....

Signature.....

Name of Seller.....

Seller Location.....

Note: The warranty form can be filled out and sent from the
website: www.dickinsonmarine.com