

User Manual

7605

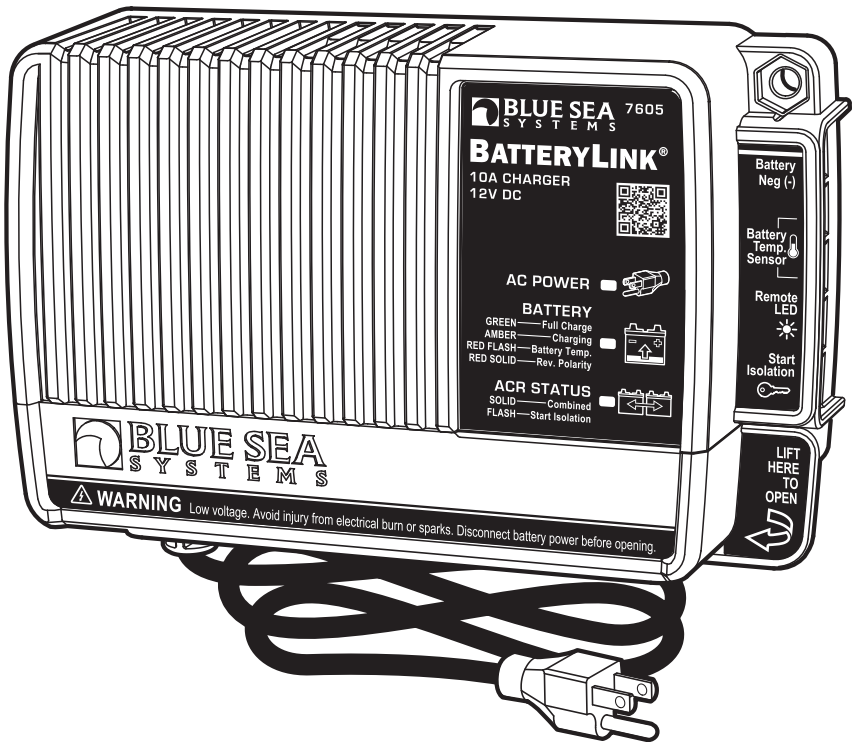



Read and understand the contents of this User Manual. It contains important safety, handling, and operational instructions for the BatteryLink[®] Chargers. This User Manual describes the product mentioned herein at the time of its publication. Specifications and performance are subject to change at the discretion of Blue Sea Systems. To view the most current revision of this publication visit blueseasystems.com/products/7605.

IMPORTANT SAFETY INSTRUCTIONS

1. READ AND SAVE THESE INSTRUCTIONS

This manual contains important safety and operating instructions for the BatteryLink® Charger.

2. **WARNING**  **RISK OF EXPLOSIVE GASES.** Working in the vicinity of a lead-acid battery is dangerous. Batteries generate explosive gases during normal battery operation. For this reason it is of the utmost importance that each time before using your charger, you read and follow the instructions provided exactly.
3. **TO REDUCE RISK OF BATTERY EXPLOSION,** follow these instructions and those marked on the battery.
4. **WARNING**  **AVOID SERIOUS INJURY OR DEATH FROM FIRE, EXPLOSION, OR ELECTRICAL SHOCK.** The BatteryLink® Charger is marked as "ignition protected" for operation in a small craft gasoline engine space. **HOWEVER:** Connection or disconnection of any electrical cables may cause sparks, which could ignite flammable gasses and cause explosion.
 - a. Never connect or disconnect electrical cables when explosive gasses may be present.
 - b. Always disconnect AC power sources before connecting or disconnecting the charger AC cord.
 - c. Connect AC plug only to a GFCI protected (Ground Fault Circuit Interrupt) outlet, and make AC connection in a secure manner that will avoid contact with water.
5. **THE BATTERYLINK® CHARGER IS DESIGNED FOR USE ONLY** in a permanent installation aboard a vessel or in a vehicle. It is not intended for use as a portable charger.
6. **USE OF AN ATTACHMENT NOT RECOMMENDED OR SOLD BY BLUE SEA SYSTEMS** may result in a risk of fire, electric shock, or injury to persons.
7. **TO REDUCE RISK OF DAMAGE TO ELECTRIC PLUG AND CORD,** pull by plug rather than cord when disconnecting charger.
8. **AN EXTENSION CORD SHOULD NOT BE USED UNLESS ABSOLUTELY NECESSARY.** Use of an improper extension cord could result in a risk of fire and electric shock. If an extension cord must be used, make sure:
 - a. That extension cord is industrial grade / heavy duty, UL approved for outdoor use, and grounded.
 - b. That pins on plug of extension cord are the same number, size, and shape as those of plug on charger.
 - c. That extension cord is properly wired and in good electrical condition, free of any damage, bent pins, or cuts to jacket or insulation.
 - d. That you always make your extension cord connection on the charger side first, and disconnect the charger side last.
 - e. That wire size is large enough for AC input ampere rating of charger. Refer to the chart below to determine the minimum wire size for extension cord.

		Minimum wire size of extension cord			
		25 ft (7.6 m)	50 ft (15.2 m)	100 ft (30.5 m)	150 ft (45.6 m)
System	120V AC	18 AWG (1 mm ²)	18 AWG (1 mm ²)	16 AWG (1.5 mm ²)	14 AWG (2.5 mm ²)
voltage	230V AC	18 AWG (1 mm ²)	18 AWG (1 mm ²)	18 AWG (1 mm ²)	16 AWG (1.5 mm ²)

9. **DO NOT OPERATE CHARGER WITH DAMAGED CORD OR PLUG.** Contact Blue Sea Systems for servicing.
10. **DO NOT OPERATE CHARGER IF IT HAS RECEIVED A SHARP BLOW,** been dropped, or otherwise damaged in any way; contact Blue Sea Systems for servicing.
11. **DO NOT DISASSEMBLE CHARGER;** contact Blue Sea Systems for servicing. Incorrect reassembly may result in a risk of electric shock or fire.
12. **TO REDUCE RISK OF ELECTRIC SHOCK,** unplug charger from outlet before attempting any maintenance or cleaning. Turning off controls will not reduce this risk.
13. **PERSONAL PRECAUTIONS**
 - a. Someone should be within range of your voice or close enough to come to your aid when working near a lead-acid battery.
 - b. Have plenty of fresh water and soap nearby in case battery acid contacts skin, clothing, or eyes.
 - c. Wear complete eye protection and clothing protection. Avoid touching eyes while working near battery.
 - d. If battery acid contacts skin or clothing, wash immediately with soap and water. If acid enters eye, immediately flood eye with running cold water for at least 10 minutes and get medical attention.

- e. NEVER smoke or allow a spark or flame in vicinity of battery or engine.
- f. Be cautious to reduce risk of dropping a metal tool onto battery. It might spark or short-circuit battery or other electrical part that may cause explosion.
- g. Remove personal metal items such as rings, bracelets, necklaces, and watches when working with a lead-acid battery. A lead-acid battery can produce a short-circuit current high enough to weld a ring or the like to metal, causing a severe burn.
- h. Use charger for charging only these battery types: Flooded lead-acid, AGM, or TPPL. It is not intended to supply power to low voltage electrical systems other than in a marine application. Do not use your marine battery charger to charge dry-cell batteries that are commonly used with home appliances. These batteries may burst and cause injury to persons and damage to property.
- i. NEVER charge a frozen battery.

14. PREPARING TO CHARGE

- a. If necessary to remove battery from boat to charge, always remove grounded negative terminal from battery first. Make sure all accessories in the boat are off, so as not to cause an arc.
- b. Be sure area around battery is well ventilated while battery is being charged.
- c. Add distilled water in each cell until battery acid reaches level specified by battery manufacturer. Do not overfill. This helps purge excessive gases from cells. For a battery without removable cell caps, such as valve regulated lead acid batteries, carefully follow manufacturer's recharging instructions.
- d. Study all battery manufacturer's specific precautions before charging, such as whether or not to remove cell caps while charging, and ensure maximum DC output amperage of charger falls within battery manufacturer's recommended rate of charge.
- e. Check that voltage of battery is 12V. Charger can be used only to charge 12V lead-acid batteries.

15. CHARGER LOCATION

- a. Never place charger directly above or below battery being charged; gases or fluids from battery will corrode and damage charger.
- b. Never allow battery acid to drip on charger when reading electrolyte specific gravity or filling battery.
- c. Do not operate charger in a closed-in area or restrict ventilation in any way.
- d. Do not set a battery on top of charger.

16. DC CONNECTION PRECAUTIONS

- a. Make or break DC output cable connections to battery only after making and verifying DC connections on the charger, and removing AC cord from electric outlet. Never allow DC output cables to touch each other.
- b. Do not make or break electrical connections to batteries while charging or for up to 30 minutes after charging.
- c. If a battery switch is installed, ensure battery switch is in the OFF position before making or breaking any connections to the battery. If no battery switch is installed, ensure all accessories are OFF.
- d. Clean battery terminals before connecting charger. Be careful to keep corrosion from eye contact.
- e. Position and secure AC and DC wires to reduce risk of damage from any door, hatch, hood, or moving engine part.
- f. Stay clear of fan blades, belts, pulleys, and other parts that can cause injury to persons.
- g. Check polarity of battery terminals before making connections.
- h. Do not face battery when making final connections, and stand as far from battery as practical.

17. WHERE APPLICABLE, EXTERNAL CONNECTIONS TO CHARGER SHALL COMPLY WITH THE UNITED STATES COAST GUARD ELECTRICAL REGULATIONS (33CFR183, SUB PART I)

18. GROUNDING AND AC POWER CORD CONNECTION INSTRUCTIONS - Charger should be grounded to reduce risk of electric shock. Charger is equipped with an electric cord having an equipment-grounding conductor and a grounding plug. The plug must be plugged into an outlet that is properly installed and grounded in accordance with all local codes and ordinances.

DANGER ⚠️ Never alter AC cord or plug provided - if it will not fit outlet, have proper outlet installed by a qualified electrician. Improper connection can result in a risk of an electric shock.

CAUTION ⚠️ Risk of Fire or Electric Shock. Connect battery charger directly to grounding receptacle (three-prong). An adapter should not be used with battery charger.

BATTERYLINK® CHARGER OVERVIEW

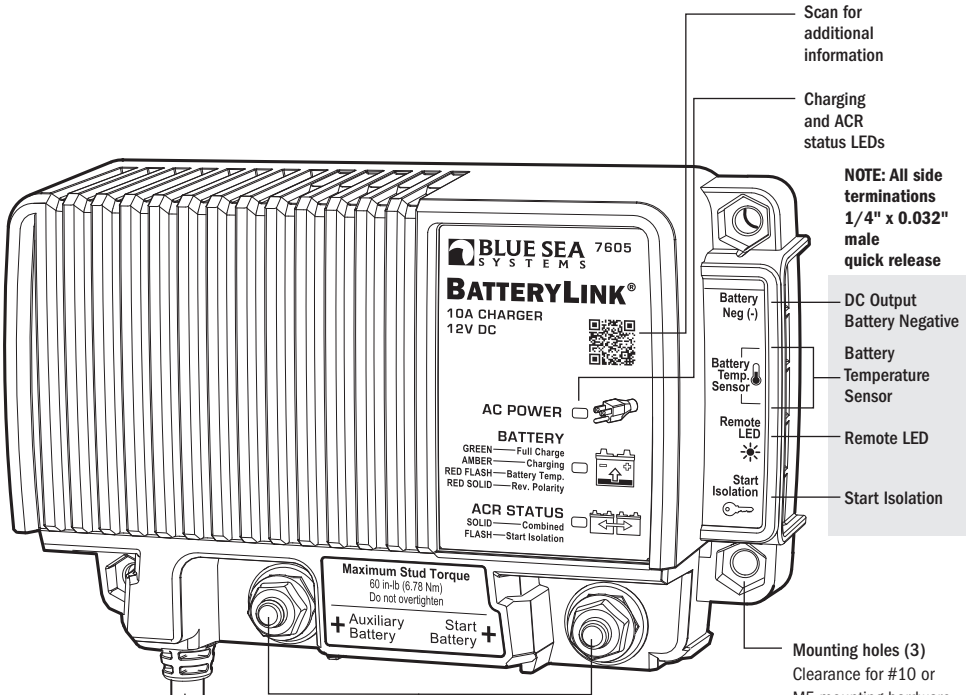

Scan for additional information

Charging and ACR status LEDs

NOTE: All side terminations 1/4" x 0.032" male quick release

DC Output Battery Negative

Battery Temperature Sensor

Remote LED

Start Isolation

Mounting holes (3)
Clearance for #10 or M5 mounting hardware. Hex recesses accept #10 (3/8" socket size) nuts.
NOTE: Mounting holes are not symmetrical, please see dimensioned drawing.

AC input 6' [1.8m] power cord with NEMA 5-15 plug

DC output battery positive connections 1/4"-20 studs accept 1/4" or M6 ring terminals. Use 7/16" socket wrench. Tighten to 60 in-lb (6.78 Nm). Do not overtighten.

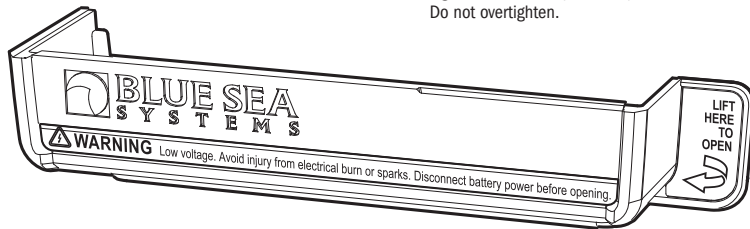

Terminations cover snaps in place to insulate battery positive terminations

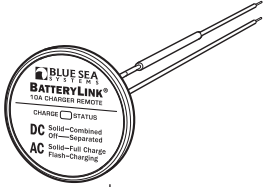

Remote LED included

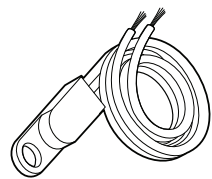

Battery temperature sensor included

BatteryLink® Charger Features

The BatteryLink® Charger is a 120VAC/230VAC nominal input, 12VDC nominal output, 10A battery charger with integral battery combiner (ACR) providing a second battery connection, as well as standard ACR function when AC power is not present.

- AC plug-in at the dock, provides 10 Amps of charge current
- Integrated ACR automatically combines batteries during charging, isolates batteries when discharging and when starting engines
- Start isolation protects sensitive electronics from voltage sags and spikes
- Battery temperature compensation prolongs battery life
- Supports alternators up to 65 Amps
- One-piece stainless flange nuts ensure safe and secure connections
- Ignition protected—safe for installation aboard gasoline powered boats
- LED light is ON when batteries are combined
- Dual Sensing—senses charge source on either battery bank
- Includes a remote indicator LED with mounting bezel
- Snap-on insulating cover

Automatic Three Stage Charging

The BatteryLink® Charger uses a three stage automatic charging profile. The three stages are referred to as bulk, absorption, and float. The charger will move between these stages automatically, with no user intervention. When the charger starts, it goes first to the bulk stage. This is where the first 75% - 80% of charging takes place. It is a constant current mode, in which the charger outputs as much current as it can to drive the voltage of the battery up to the absorption voltage. Once the absorption voltage is reached, the charger enters absorption mode. This is a constant voltage mode, in which the battery is held at the absorption voltage to complete the last 20% - 25% of charging. In the absorption stage, current will decrease according to the Batteries' needs plus any additional current required for active loads. The length of time spent in the absorption stage will vary based on battery type, battery capacity, and the presence of loads, but will be a minimum of 1 hour up to a maximum of 5 hours. After the absorption stage, the charger will move to the float stage. The float stage is a constant voltage mode intended to maintain fully charged batteries while supplying current for loads as necessary. After seven days of continuous float mode, the charger will repeat the normal charge cycle to assure good battery health.

Battery Temperature Compensation

Battery temperature compensation is output voltage regulation based on battery temperature variances. Since batteries can see extreme temperature differences, it is important to regulate output voltage with temperature to maximize battery life. A battery in a cold environment should not be charged at the same voltage as a battery in a hot environment. The BatteryLink® Charger is set at a baseline of 25°C. If the included battery temperature sensor is installed, then every 5°C variance from this baseline will result in a change in output voltage. Voltage will decrease at higher temperatures, and increase at lower temperatures. The temperature sensor also allows the charger to react to extreme hot or cold temperatures (below 0°C or above 45°C) by reducing output or shutting down to preserve the battery. Reference the Installation Instructions on page 6 and the Full Installation Diagram on page 8 for details on how to install the battery temperature sensor.

Automatic Charging Relay (ACR)

The BatteryLink® Charger includes an integrated 65A Automatic Charging Relay (ACR). The purpose of an ACR is to combine batteries for charging, but leave them isolated for discharge. This works well with dual battery systems, where non-starting loads are isolated from the engine starting battery to reduce the risk of being stranded on the water without enough power to start your engine. The ACR in the BatteryLink® Charger will combine the auxiliary and start batteries at or away from the dock. This means both batteries will be charged during AC powered charging, or when AC power is not available and a secondary charging source is active, such as your engine's alternator. The ACR includes an optional Start Isolation feature, which can be used to prevent engine starting current being drawn from the auxiliary battery. Start Isolation protects sensitive electronics wired to the auxiliary battery from being affected by voltage sags or spikes caused by engine starting. Reference the Installation Instructions on page 6 and the Full Installation Diagram on page 8 for details on how to wire the Start Isolation feature.

Supplies Needed

- DC Wire: Black or yellow for negative, red for each positive. **NOTE:** All wiring should be of sufficient length to allow proper routing, support, drip loops, service loops, and termination.
- Fuse holders for connection to each battery, for charger negative, and for optional Start Isolation and Remote LED wiring if used (see Full Installation Diagram, page 8).
- Fuses for fuse holders (see table below and Full Installation Diagram, page 8).
- Screwdriver: Phillips #2 for mounting screws.
- Socket wrench (torque wrench preferred): 7/16" socket for DC battery positive connections. Other socket sizes as needed for connection to battery and fuse holder terminals.
- Terminals: 1/4" or M6 ring terminals for charger side DC battery positive connections. 1/4" x 0.032" female quick disconnect terminals for DC battery negative and accessory connections. Other ring terminals sized for connection to battery and fuse holder terminals.
- Appropriately sized butt connectors for extending remote LED and battery temperature sensor wires.
- Crimping tool or obtain wires that are pre-terminated.
- Appropriate heat shrink if pre-terminated wires were not acquired.

Wire Size and Fuse Rating Table*

Conductor Length in feet (meters)		Positive Wire (sized for maximum alternator output)			Negative Wire (sized for 10A charger output)
		Alternator up to 30A	Alternator up to 50A	Alternator up to 65A	
6 ft (1.83 meters)		10 AWG (6 mm ²)	6 AWG (16 mm ²)	6 AWG (16 mm ²)	14 AWG (2.5 mm ²)
10 ft (3.05 meters)		6 AWG (16 mm ²)	4 AWG (25mm ²)	4 AWG (25mm ²)	12 AWG (4 mm ²)
15 ft (4.57 meters)		6 AWG (16 mm ²)	2 AWG (35 mm ²)	2 AWG (35 mm ²)	10 AWG (6 mm ²)
20 ft (6.09 meters)		4 AWG (25mm ²)	2 AWG (35 mm ²)	1 AWG (50 mm ²)	8 AWG (10 mm ²) **
25 ft (7.62 meters)		2 AWG (35 mm ²)	1 AWG (50 mm ²)	1/0 AWG (70 mm ²)	8 AWG (10 mm ²) **
Recommended Fuse Rating ***		40A	60A	90A-100A	30A (see next row)
Fuse Required For Negative?		YES, if negative wire is < 12 AWG (4 mm ²)	YES, if negative wire is < 8 AWG (10 mm ²)	YES	-
Fuse Type	Fuse Holder PN	Recommended Blue Sea Systems Fuse PN			
MRBF Fuse	5191	5176 (40A)	5178 (60A)	5182 (90A)	Not Recommended
AMI®/MIDI® Fuse	7720	5251 (40A)	5253 (60A)	5256 (100A)	5250 (30A)
ATO®/ATC® Fuse	5065	Not Recommended	Not Recommended	Not Recommended	5245 (30A)

* Based on 3% voltage drop. If fast charge recovery is important, use larger wire.

** If marine grade 8 AWG (10 mm²) 1/4" quick connect terminals are not readily available, it is recommended to make a short 10 AWG (6 mm²) jumper to a terminal block or PowerPost, and then continue from that point with 8 AWG (10 mm²) cable.

*** Fuses in positive wires should be located as close as possible to the battery positive terminal, per ABYC recommendations. If required, the fuse in the negative wire should be located as close as possible to the charger.

For more information please use the Circuit Wizard at circuitwizard.bluesea.com

LED Status Indicators

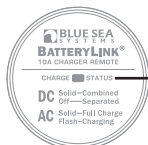
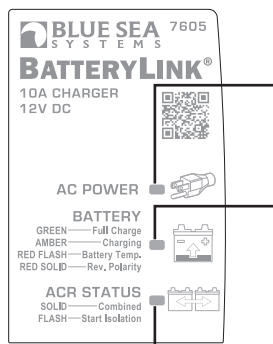

Name		States	
AC POWER		Green solid	AC power present
		Off	No AC power
BATTERY		Green solid	Charging complete - Float stage
		Amber solid	Charging in progress - Bulk or absorption stage
		Red single blink	Battery hot - Charger shutdown (>=50°C)
		Red double blink	Battery hot - Output reduction (>=45°C and <50°C)
		Red triple blink	Battery cold - Charger shutdown (<= 0°C)
		Red solid	Battery polarity reversed
ACR STATUS		Off	No AC power
		Green solid	Combined - ACR closed
		Double-blink	SI present - ACR open
REMOTE LED CHARGE STATUS	DC Power	Off	Battery voltages below threshold - ACR open
		Solid	Combined - ACR closed
	AC Power	Off	Separated - ACR open
		Solid	Charging complete - Float stage
		Flash	Charging in progress - Bulk or absorption stage
		Solid	Charging complete - Float stage

INSTALLATION INSTRUCTIONS

1. Before beginning electrical installation, disconnect all positive and negative AC and DC power sources.

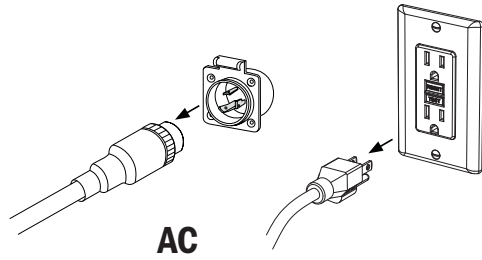
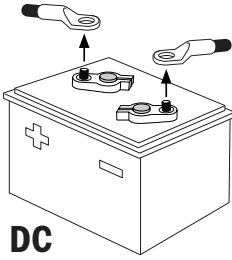

2. For optimal performance, mount the charger vertically, in a well ventilated location.
NOTE: The charger should be located near the batteries to minimize wire length and its associated voltage drop to maximize charging efficiency. If the batteries are not close together, place the charger near the largest battery.
3. Remove the DC termination cover by lifting the tab on the right hand side.
4. Route DC wires from each charger output to battery fuse holder. See Installation Diagrams on pages 7 and 8. All wiring should be of sufficient length to allow proper routing, support, drip loops, service loops, and termination. Strain relief for wiring should be installed near the charger to prevent loosening of connections with vibration or shock. Fuses should be installed at the battery positive connections to prevent battery power from feeding back into a fault in the wiring, or in the battery charger. See Wire Size And Fuse Rating Table on page 5 for recommended fuse values. Best practices and ABYC standards recommend that every positive wire on the boat, outside the engine starting circuit, must have circuit protection. Please reference ABYC E-11 electrical standard for the most up to date recommendations.
5. Recommended Connection [Battery Temperature Sensor]: Attach the battery temperature sensor to the largest battery using the supplied adhesive pad. If both batteries are the same size, attach to the battery with the most loads. Attach the sensor in the center of the long side of the battery. If multiple batteries are in a battery bank, attach the sensor in the center between multiple batteries. When external circumstances could create a significant difference in temperature on one side of a battery versus another, always attach the sensor on the warmest side. NEVER pierce the battery casing with a screw or other fastener. Extend sensor wires as necessary to reach the charger using appropriate fully insulated butt connectors or a terminal block with insulating cover.
6. Optional Installation [Remote LED Bezel]: Drill a 7/16" [11mm] hole through a flat mounting surface in a visible location. Clean and dry the surface around the drilled hole for best adhesion of the bezel. Remove the adhesive backing liner from the bezel, thread the LED wires through the hole, and push the bezel securely into place against the mounting surface. Extend the LED wires as necessary using appropriate fully insulated butt connectors or a terminal block with insulating cover. Connect the positive (red) wire from the LED to your battery positive terminal through a 2A fuse at the battery. Place this connection on top of all current carrying conductors. Connect the negative (yellow) wire from the LED to the charger Remote LED terminal.
7. Optional Connection [Start Isolation-protects sensitive electronics from voltage drops and spikes during engine start]: Connect the Start Isolation terminal of the charger to the "start" position of your engine's ignition switch, or another connection point that has positive voltage applied only when actively cranking your engine. Install a 2A fuse at the point of connection to positive voltage.
8. Install appropriate DC fuses (see Wire Size And Fuse Rating Table on page 5).
9. Confirm all connections are correctly installed per Installation Diagrams.
10. Secure the termination cover back over the connected wires.
11. Make AC plug connection to an appropriate outlet.
12. Restore AC power.

QUICK INSTALLATION DIAGRAM

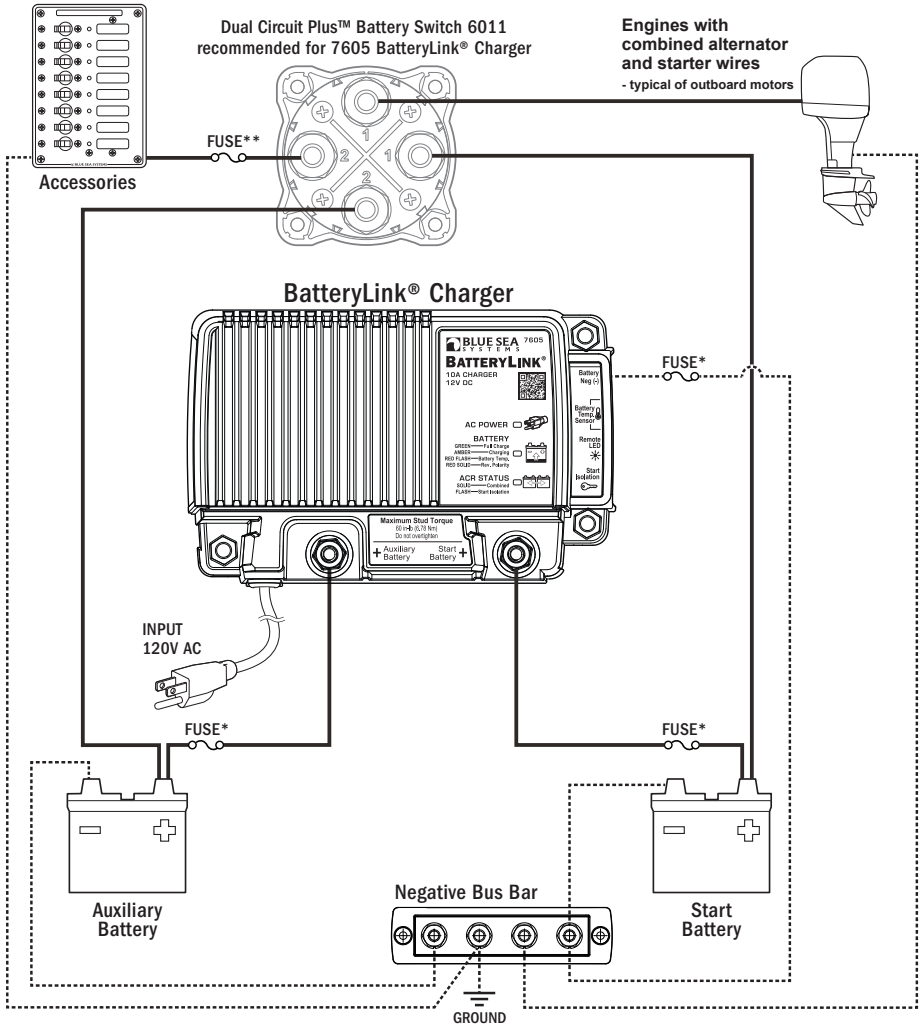

Legend

DC Negative ----- DC Positive ———

* See Wire Size and Fuse Rating Table, page 5.

** Wire size and fuse rating based on house loads. For more information, use the Circuit Wizard at circuitwizard.bluesea.com.

FULL INSTALLATION DIAGRAM

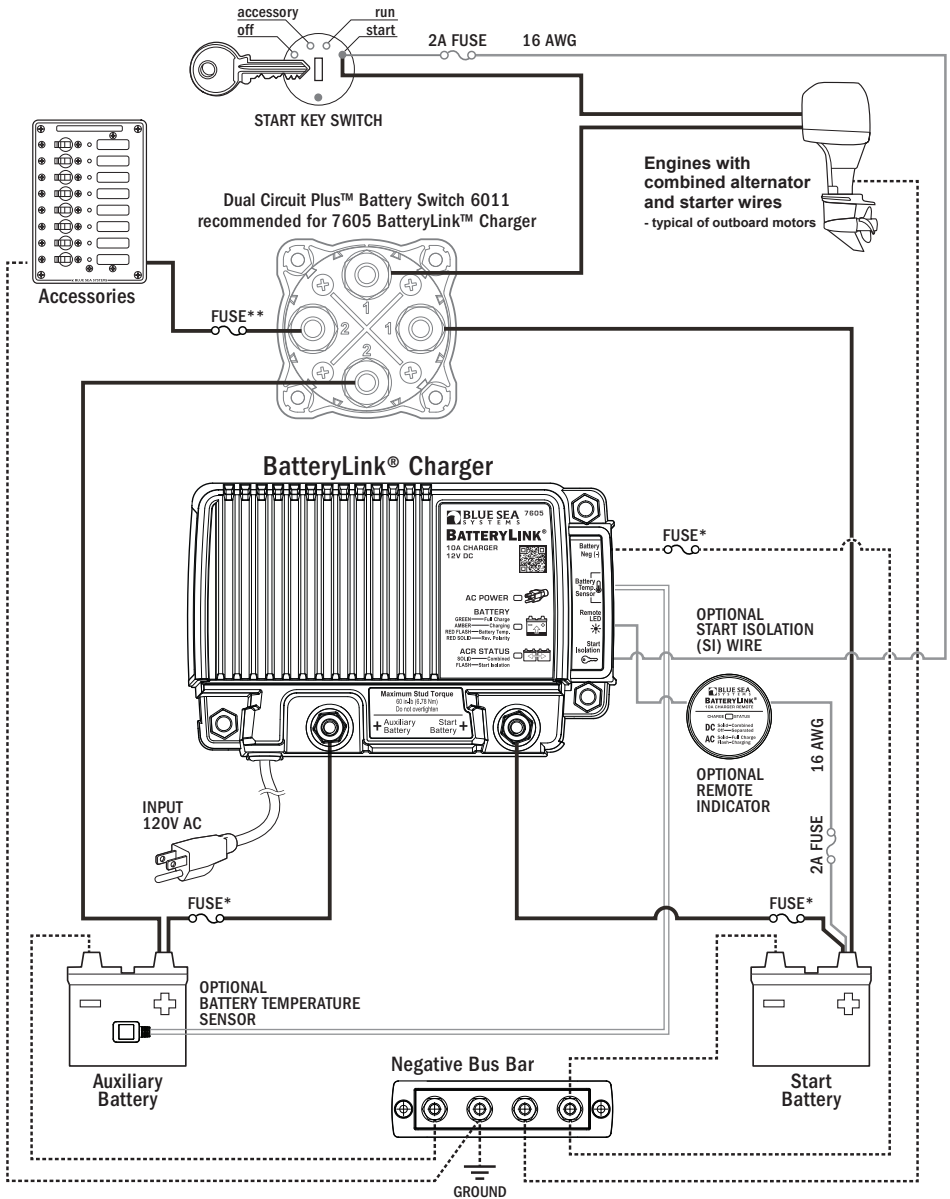

Legend

DC Negative ----- Optional ———— DC Positive ————

* See Wire Size and Fuse Rating Table, page 5.

** Wire size and fuse rating based on house loads. For more information, use the Circuit Wizard at circuitwizard.bluesea.com.

Specifications

Nominal Output Voltage	12V DC
Total Output Current (25°C)	10A
Output Connections	2 positive, 1 negative
Universal AC Input Voltage	90V-265V AC
Input Frequency Range	50/60 Hz
AC Input Current	3.25A @ 100V 1.75A @ 200V
Typical Float Voltage (25°C)	13.5V DC
Typical Absorption Voltage (25°C)	14.4V DC
Battery Temperature Compensation Coefficient	-30 mV/°C
ACR Continuous Rating	65A
ACR Continuous Rating (during AC charging)	40A
ACR Intermittent Rating (5 min.)	115A
ACR Combine Voltage	13.0V (2 min.) 3.5V (30 sec.)
ACR Open Voltage	12.35V (10 sec.) 12.75V (30 sec.)
Operating Current (no AC power)	10mA (ACR open) 60mA (ACR closed)
Maximum Cable Size	1/0 AWG (50mm ²)
Terminal Stud Size	1/4"-20 (accepts M6 ring terminal)
Maximum Terminal Stud Torque	60 in-lb (6.8 Nm)
Quick Connect Terminal Size	1/4" x 0.032"
Operating Temperature Range	0°C – 50°C
Storage Temperature Range	-30°C – 80°C
Warranty	5 Year
Battery Types	Flooded, AGM, TPPL
Maximum Battery CCA	850 CCA

Regulatory

Designed and constructed for compliance to UL-1236 Marine, CSA 22.2 No. 107.2, and ABYC A-31 standards. Ignition protection per ISO 8846, and SAE J1171. Meets FCC Part 15, Class B requirements. Waterproof IP67 - protected against immersion up to 1 meter for 30 minutes



DIMENSIONED DRAWINGS

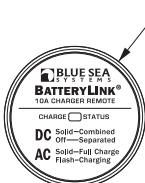
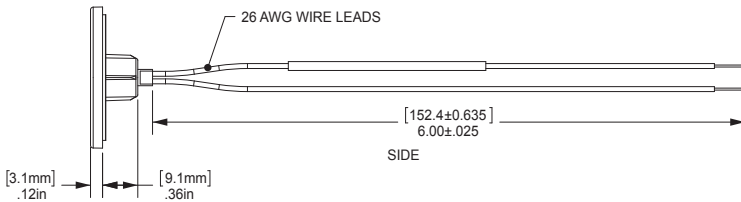
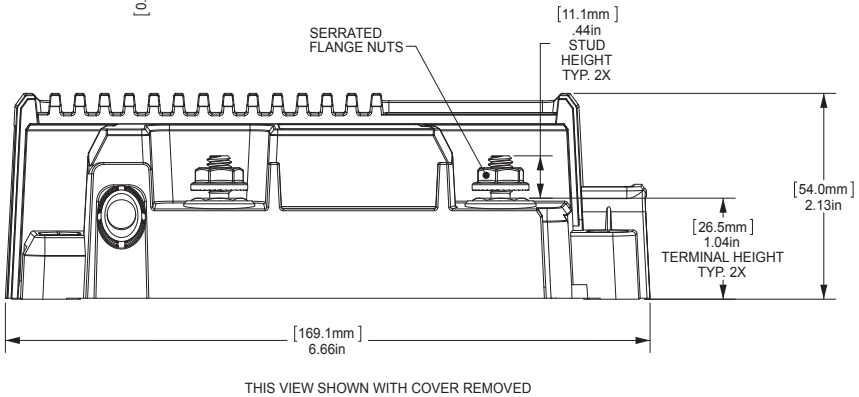
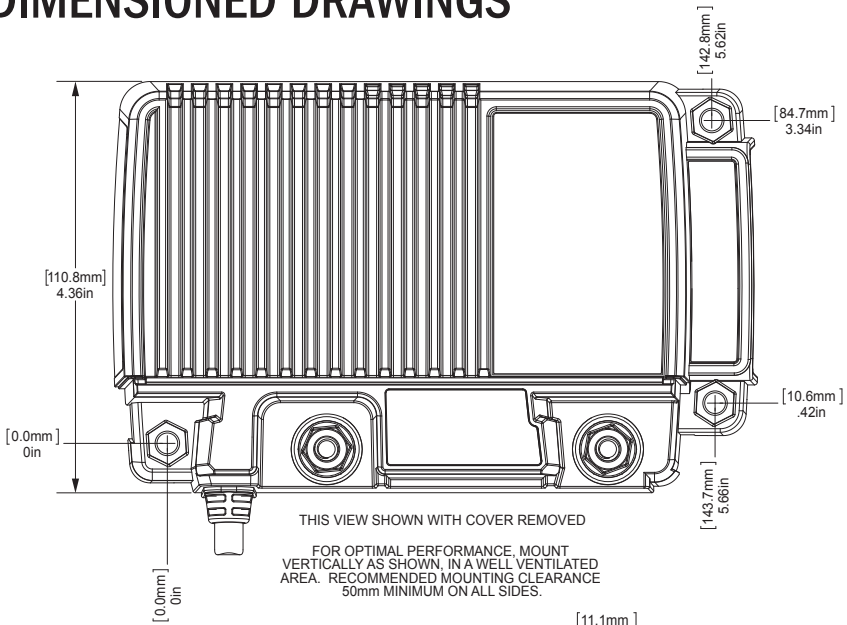

FRONT

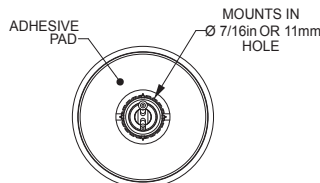

BACK



425 Sequoia Drive
Bellingham, WA 98226 USA

p 360.738.8230
p 800.222.7617 USA and Canada Customer Service
f 360.734.4195
conductor@blueseasystems.com
www.blueseasystems.com

980022760 Rev. 001